

Brass Battery Terminals



Phoenix Metal Craft
An immortal spirit of manufacturing



COMPANY PROFILE

Phoenix Metal Craft successfully established itself as a highly reliable manufacturer, exporter and trader of a range of automotive parts, precision brass fitting parts and manufacture any metal parts i.e. Brass, M.S, S.S, Copper, Aluminium etc, as per customer provided drawing, specifications or sample.

We are equipped with machinery consisting of header machines station header machine, CNC, Turning machine and highspeed roll die threading machine. We are quality conscious and at the same time competitive enough to be an attractive supplier to you. The Quality ranges that we manufacture are highly durable and chemical resistant.

We always welcome to the development of the new Products. We Manufacture Brass, Copper & Other Metal Components on the base of Sample, Drawing, or Standards reference. Our Products have confirmed the requirement of RoHS of European Standard.

OUR PRODUCTS RANGE

- Brass Ball Valve
- Brass Battery Terminals
- Brass Cable Glands
- Brass Earthing Equipments And Accessories
- Brass Electrical Plug Pins And Sockets
- Brass Fasteners
- Brass HRC Fuse Contacts
- Brass Insert
- Brass Neutral Link
- Brass Sheet Cutting And Pressed Parts
- Brass Standoff And Spacer
- Brass Terminals For PCB Connector Block
- Brass Hardware Products
- CNC Turned Parts
- Special Brass Turned Parts
- Any Kind of Metal Components As Per Sample, Drawing or Standard Reference

**Let's make something innovative together,
We welcome you to share a healthy long-term business relationship with us.**



+91-81418 76969
+91-99783 05054



phoenix@phoenixmetalcraft.com
www.phoenixmetalcraft.com



Shed No. 402/A, Above Dhiraj Sales,
G.I.D.C., Udyog Nagar, Shankar Tekri,
Jamnagar - 361005

Brass Battery Terminals

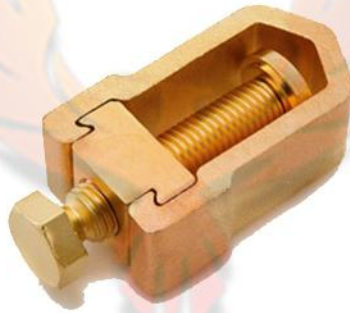

Phoenix Metal Craft
An immortal spirit of manufacturing



+91-81418 76969
+91-99783 05054



phoenix@phoenixmetalcraft.com
www.phoenixmetalcraft.com



Shed No. 402/A, Above Dhiraj Sales,
G.I.D.C., Udyog Nagar, Shankar Tekri,
Jamnagar - 361005

Brass Battery Terminals



+91-81418 76969
+91-99783 05054



phoenix@phoenixmetalcraft.com
www.phoenixmetalcraft.com



Shed No. 402/A, Above Dhiraj Sales,
G.I.D.C., Udyog Nagar, Shankar Tekri,
Jamnagar - 361005

Brass Battery Terminals



PRODUCT DETAILS & SPECIFICATION

We Are Highly Experienced Manufacturer, Supplier And Exporter Of Various Types Of Brass Products Such As Brass Auto Parts (Battery Terminals) Including Machine Made Battery Terminal And Forged Battery Terminal. These Are Mainly Used For Connecting Batteries In Auto Industry And Inverter Batteries. We Take Due Care That Terminal Are Not Rough And Don't Have Any Sharp Edges, To Make Sure The Wires Are Not Damaged While Installing. We Also Offer Various Types Of Brass Auto Parts And Battery Terminal According To Customer's Drawings Or Specifications.

Specification:

IS 1367, BS 3692, Fire Retardant - UL94V-0

Material:

Free Cutting Brass IS 319 Type (I) or BS 249 Type (I) or High Grade, Any Special Material Composition as per customers requirement, sample and design.

Threads:

ISO Metric (MM Threads), BA Threads, BSW Threads (Inches), UNC, UNF Threads, Any Threads As Per Custom Design

Types:

Lucas Type, Angle Type, Ship Type, Toyota Type, U.S.A. Car Type, Seiver Type(Universal Type) in forging and casted.

Forged Type:

Seiver Crimp Type, Angle (Bosch) Type, USA Car Type, Post Type (Machined), Cable Lugs (Brass), Solder Type (Machined), Solder Less (Screw) Type (Machined), Solder Less (Screw) Type (Machined), Hex Head Bolt Type (Machined)

Use:

Conduct Electricity

Let's make something innovative together, Contact Us



+91-81418 76969
+91-99783 05054



phoenix@phoenixmetalcraft.com
www.phoenixmetalcraft.com



Shed No. 402/A, Above Dhiraj Sales,
G.I.D.C., Udyog Nagar, Shankar Tekri,
Jamnagar - 361005



Phoenix Metal Craft

An immortal spirit of manufacturing



Brass Electrical Plugs, Pins & Sockets

COMPANY PROFILE

Phoenix Metal Craft successfully established itself as a highly reliable manufacturer, exporter and trader of a range of automotive parts, precision brass fitting parts and manufacture any metal parts i.e. Brass, M.S, S.S, Copper, Aluminium etc, as per customer provided drawing, specifications or sample.

We are equipped with machinery consisting of header machines station header machine, CNC, Turning machine and highspeed roll die threading machine. We are quality conscious and at the same time competitive enough to be an attractive supplier to you. The Quality ranges that we manufacture are highly durable and chemical resistant.

We always welcome to the development of the new Products. We Manufacture Brass, Copper & Other Metal Components on the base of Sample, Drawing, or Standards reference. Our Products have confirmed the requirement of RoHS of European Standard.

OUR PRODUCTS RANGE

- Brass Ball Valve
- Brass Battery Terminals
- Brass Cable Glands
- Brass Earthing Equipments And Accessories
- Brass Electrical Plug Pins And Sockets
- Brass Fasteners
- Brass HRC Fuse Contacts
- Brass Insert
- Brass Neutral Link
- Brass Sheet Cutting And Pressed Parts
- Brass Standoff And Spacer
- Brass Terminals For PCB Connector Block
- Brass Hardware Products
- CNC Turned Parts
- Special Brass Turned Parts
- Any Kind of Metal Components As Per Sample, Drawing or Standard Reference

**Let's make something innovative together,
We welcome you to share a healthy long-term business relationship with us.**



+91-81418 76969
+91-99783 05054



phoenix@phoenixmetalcraft.com
www.phoenixmetalcraft.com



Shed No. 402/A, Above Dhiraj Sales,
G.I.D.C., Udyog Nagar, Shankar Tekri,
Jamnagar - 361005

Brass Electrical Plugs, Pins & Sockets



EPS - 0002



EPS - 0001



EPS - 0003



EPS - 0004



EPS - 0005



EPS - 0006



EPS - 0007

Brass Electrical Plugs, Pins & Sockets



Product Details & Specification

Owing to years of industrial experience, Phoenix Metal Craft providing broad gamut of Brass Electrical Plug Pins manufactured using latest technology and modern machinery. Brass Electrical Plug Pins are widely used as a component to be installed electrical wire. Our Electrical plugs and pins are highly appreciated by customer across various industry for its sturdy finish and accurate dimension. Electrical Plug Pins we manufacture are shock proof, crack resistance and highly reliable. Our wide range of electrical plug pin include neutral pins, earth pins, knurled pins, slotted pins and more. Electrical plug pins are also available with DIN screw as per customer specification and requirements. We can develop and supply standard as well as custom brass electrical plug pins exactly as per customer specifications.

Material:

Brass to BS 2874 / 2872, Free Cutting brass, High Grade Brass, Copper, Carbon Steel, Alloy Steel, Duplex Steel, Stainless Steel, Bronze, Mild Steel, Aluminium, Any special material as per customer requirements.

Threads/Standards:

Metric Coarse, Metric Fine, ISO Metric. , UNC, UNF, NPT, BSP or PG. , BSW, BSF and BA. ,DIN Standards. GB Standard Threads.

Finish/Coating:

Natural, Nickel, Zinc, Zinc alloy, Stainless Steel, and any finish as per customer requirements.

Features:

Provide Quick and Easy Installation. Provide Space Saving Connection and Installation. Corrosion and Rust Resistant. Provide High Electrical Conductivity. Available with Safety Standards and compliance. Custom Specific Range also available.

Application:

Suitable for various electrical connection type. Suitable for different types of Plugs and Sockets. Widely used for securing electrical connection in Telecommunication, Electrical, Electronics, Automotive, Construction and other Industries.

Brass Inserts



Phoenix Metal Craft
An immortal spirit of manufacturing

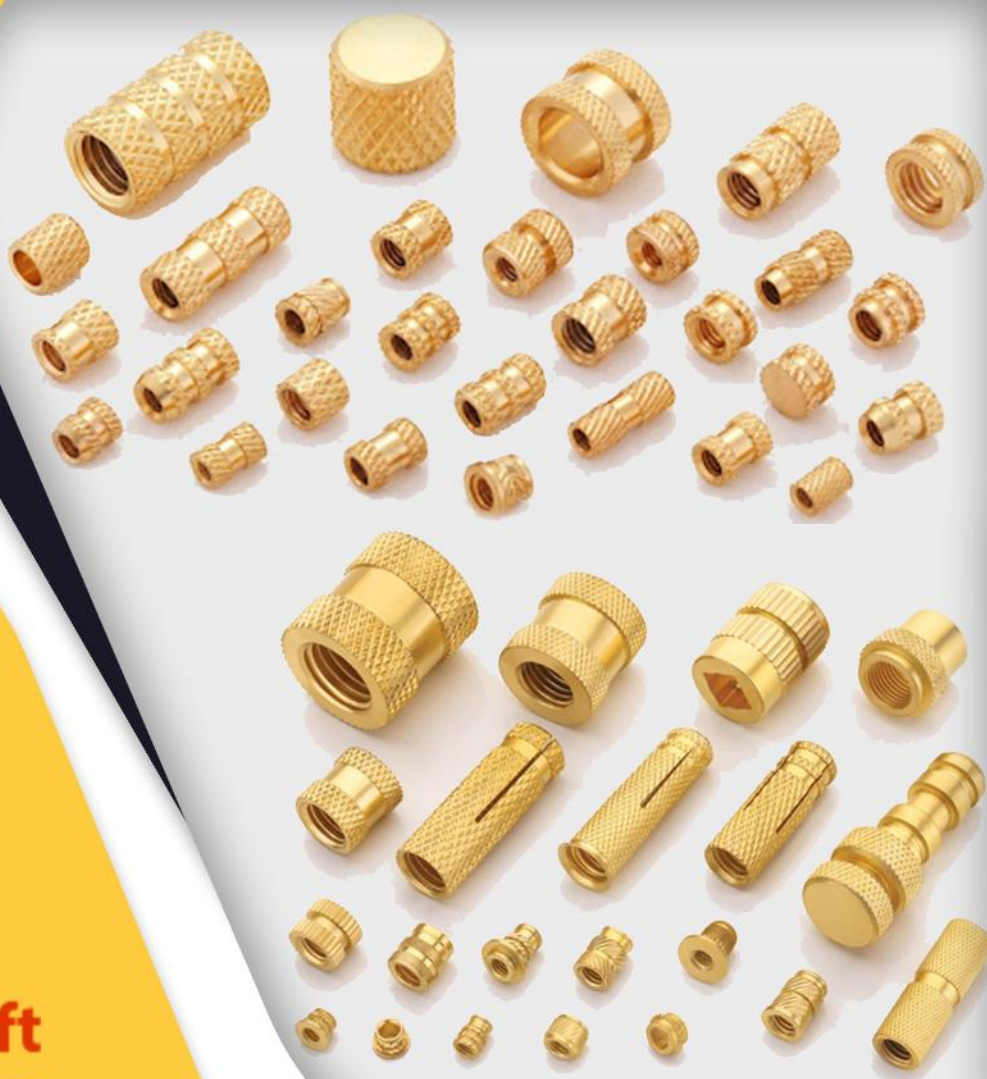

COMPANY PROFILE

Phoenix Metal Craft successfully established itself as a highly reliable manufacturer, exporter and trader of a range of automotive parts, precision brass fitting parts and manufacture any metal parts i.e. Brass, M.S, S.S, Copper, Aluminium etc, as per customer provided drawing, specifications or sample.

We are equipped with machinery consisting of header machines station header machine, CNC, Turning machine and highspeed roll die threading machine. We are quality conscious and at the same time competitive enough to be an attractive supplier to you. The Quality ranges that we manufacture are highly durable and chemical resistant.

We always welcome to the development of the new Products. We Manufacture Brass, Copper & Other Metal Components on the base of Sample, Drawing, or Standards reference. Our Products have confirmed the requirement of RoHS of European Standard.

OUR PRODUCTS RANGE

- Brass Ball Valve
- Brass Battery Terminals
- Brass Cable Glands
- Brass Earthing Equipments And Accessories
- Brass Electrical Plug Pins And Sockets
- Brass Fasteners
- Brass HRC Fuse Contacts
- Brass Insert
- Brass Neutral Link
- Brass Sheet Cutting And Pressed Parts
- Brass Standoff And Spacer
- Brass Terminals For PCB Connector Block
- Brass Hardware Products
- CNC Turned Parts
- Special Brass Turned Parts
- Any Kind of Metal Components As Per Sample, Drawing or Standard Reference

**Let's make something innovative together,
We welcome you to share a healthy long-term business relationship with us.**



+91-81418 76969
+91-99783 05054



phoenix@phoenixmetalcraft.com
www.phoenixmetalcraft.com



Shed No. 402/A, Above Dhiraj Sales,
G.I.D.C., Udyog Nagar, Shankar Tekri,
Jamnagar - 361005

Brass Inserts



BI - 0001



BI - 0002



BI - 0003



BI - 0004



BI - 0005



BI - 0006



BI - 0007

Phoenix Metal Craft
An immortal spirit of manufacturing



BI - 0008



BI - 0009



+91-81418 76969
+91-99783 05054



phoenix@phoenixmetalcraft.com
www.phoenixmetalcraft.com



Shed No. 402/A, Above Dhiraj Sales,
G.I.D.C., Udyog Nagar, Shankar Tekri,
Jamnagar - 361005

Brass Inserts

Product Details & Specification

We are the leading manufacturer of Brass threaded inserts for plastics industries, communication equipments, automotive industries, electrical & Wiring device cases etc. We offer a full line of brass inserts for all methods of installation, including: ultrasonic, heat, thermal, press-in and mold-in. Although we produce various brass inserts as per custom design & specification.

We have standard series of Threaded Inserts such as Straight Hole, Blind (Closed bottom), Collar Inserts, Ultrasonic, Press in, Tri Slotted Inserts, Brass Threaded Inserts, Brass Knurled Inserts, Brass Inserts for Plastics, Brass Inserts for Wood and Clipboard, Ultrasonic range of Brass Inserts, Heatbit range of Brass Inserts, Press-in Inserts with and without collars, Moulded-in Inserts etc. can be done as per customers requirement.

Material:

Generally Free Machine Grade of CuZn37Pb3 equivalent to BS 2874 is used to manufacture various brass inserts in form of round, Hexagon, Square etc. Other grades which are followed as per custom requirements are CZ 121, CZ 131, C3604, CDA 360 and DTD 627 etc.

Key Features:

- Thread Size Starts from M1.6 to M50. BA, BSW, BSPT, BSF & American Threads like UNC, UNF, UNEF and NPT are also available as per custom requirements.
- Straight, Diamond, opposite diagonal etc. are the knurling options available to give solid gripping to Molding applications.
- Inserts available as per Class 2B ANSI/ASME B1.1 & Confirms to ISO metric 6H Thread Standards.
- Inserts with collar series provides Options to use Flange to make Electric Contact.
- Ultrasonic series with Opposing Diagonal Knurls provide excellent Torque Resistance Vertical Undercuts in Tri Series Provides Superior Tensile Strength
- Blind thread or closed bottom Inserts prevents plastic from entering the bottom of the insert.

Finish/Coating:

Generally Brass Inserts comes with the Natural, Nickel & Tin Finish. But Surface Finishes such as Chromium, Silver, Gold, etc. can be done as per customers requirement.

Application:

Suitable for Instrumentation, Telecommunications, and other Plastic Cases Assembly.

Also Available:

Brass Round Knurled Inserts
Brass Hexagonal Inserts
Brass Square Inserts



+91-81418 76969
+91-99783 05054



phoenix@phoenixmetalcraft.com
www.phoenixmetalcraft.com



Shed No. 402/A, Above Dhiraj Sales,
G.I.D.C., Udyog Nagar, Shankar Tekri,
Jamnagar - 361005

Brass Terminals For PCB Connector



Phoenix Metal Craft
An immortal spirit of manufacturing



COMPANY PROFILE

Phoenix Metal Craft successfully established itself as a highly reliable manufacturer, exporter and trader of a range of automotive parts, precision brass fitting parts and manufacture any metal parts i.e. Brass, M.S, S.S, Copper, Aluminium etc, as per customer provided drawing, specifications or sample.

We are equipped with machinery consisting of header machines station header machine, CNC, Turning machine and highspeed roll die threading machine. We are quality conscious and at the same time competitive enough to be an attractive supplier to you. The Quality ranges that we manufacture are highly durable and chemical resistant.

We always welcome to the development of the new Products. We Manufacture Brass, Copper & Other Metal Components on the base of Sample, Drawing, or Standards reference. Our Products have confirmed the requirement of RoHS of European Standard.

OUR PRODUCTS RANGE

- Brass Ball Valve
- Brass Battery Terminals
- Brass Cable Glands
- Brass Earthing Equipments And Accessories
- Brass Electrical Plug Pins And Sockets
- Brass Fasteners
- Brass HRC Fuse Contacts
- Brass Insert
- Brass Neutral Link
- Brass Sheet Cutting And Pressed Parts
- Brass Standoff And Spacer
- Brass Terminals For PCB Connector Block
- Brass Hardware Products
- CNC Turned Parts
- Special Brass Turned Parts
- Any Kind of Metal Components As Per Sample, Drawing or Standard Reference

**Let's make something innovative together,
We welcome you to share a healthy long-term business relationship with us.**



+91-81418 76969
+91-99783 05054



phoenix@phoenixmetalcraft.com
www.phoenixmetalcraft.com



Shed No. 402/A, Above Dhiraj Sales,
G.I.D.C., Udyog Nagar, Shankar Tekri,
Jamnagar - 361005

Brass Terminals For PCB Connector

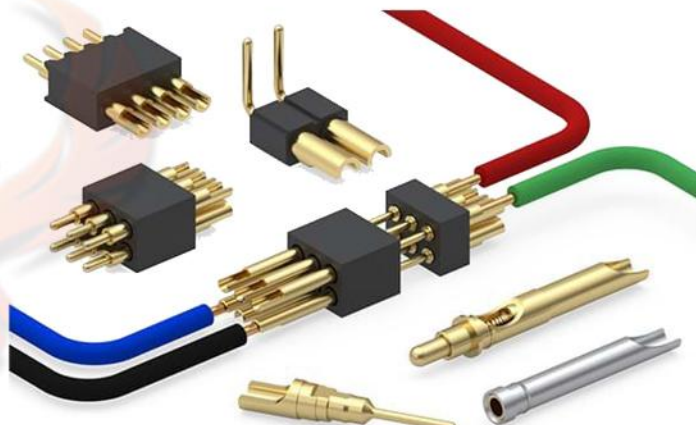

Phoenix Metal Craft
An immortal spirit of manufacturing



+91-81418 76969
+91-99783 05054



phoenix@phoenixmetalcraft.com
www.phoenixmetalcraft.com



Shed No. 402/A, Above Dhiraj Sales,
G.I.D.C., Udyog Nagar, Shankar Tekri,
Jamnagar - 361005

Brass Terminals For PCB Connector

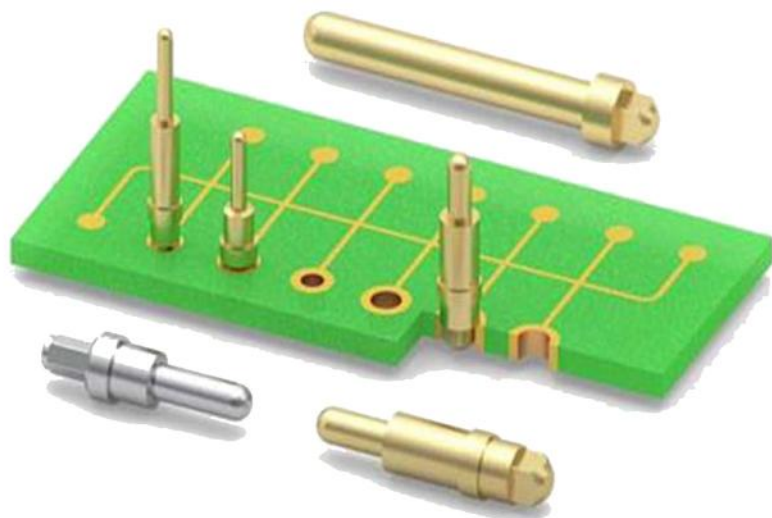

PRODUCT DETAILS & SPECIFICATION

We are leading manufacturer and supplier of Brass PCB Terminals that is widely used across different applications in electronic and electrical industries and many others. We use high grade raw materials for production of Brass PCB Terminals Block in observance with excellent strength, high durability and quality standards. we can develop Any kind of PCB Terminals exactly as per customer specifications.

Material:

Free Cutting Brass IS 319 Type (I) or BS 249 Type (I) or High Grade, Any Special Brass Material Composition as per customers requirement

Threads:

ISO Metric (MM Threads), BA, BSW (Inches), UNC, UNF or Any as per custom design.

Sizes & Types:

Any size & types as per custom design or requirement

Finish:

Natural, Nickle Plated, Tin Plated brass terminals for PCB connector block or any coating as per customer specification.

Specification:

Any kind of brass terminals for PCB connector block can be developed and supplied exactly as per customer design, sample and specifications.

Let's make something innovative together, Contact Us



+91-81418 76969
+91-99783 05054



phoenix@phoenixmetalcraft.com
www.phoenixmetalcraft.com



Shed No. 402/A, Above Dhiraj Sales,
G.I.D.C., Udyog Nagar, Shankar Tekri,
Jamnagar - 361005

Brass Cable Glands



Phoenix Metal Craft
An immortal spirit of manufacturing



COMPANY PROFILE

Phoenix Metal Craft successfully established itself as a highly reliable manufacturer, exporter and trader of a range of automotive parts, precision brass fitting parts and manufacture any metal parts i.e. Brass, M.S, S.S, Copper, Aluminium etc, as per customer provided drawing, specifications or sample.

We are equipped with machinery consisting of header machines station header machine, CNC, Turning machine and highspeed roll die threading machine. We are quality conscious and at the same time competitive enough to be an attractive supplier to you. The Quality ranges that we manufacture are highly durable and chemical resistant.

We always welcome to the development of the new Products. We Manufacture Brass, Copper & Other Metal Components on the base of Sample, Drawing, or Standards reference. Our Products have confirmed the requirement of RoHS of European Standard.

OUR PRODUCTS RANGE

- Brass Ball Valve
- Brass Battery Terminals
- Brass Cable Glands
- Brass Earthing Equipments And Accessories
- Brass Electrical Plug Pins And Sockets
- Brass Fasteners
- Brass HRC Fuse Contacts
- Brass Insert
- Brass Neutral Link
- Brass Sheet Cutting And Pressed Parts
- Brass Standoff And Spacer
- Brass Terminals For PCB Connector Block
- Brass Hardware Products
- CNC Turned Parts
- Special Brass Turned Parts
- Any Kind of Metal Components As Per Sample, Drawing or Standard Reference

Let's make something innovative together,
We welcome you to share a healthy long-term business relationship with us.



+91-81418 76969
+91-99783 05054



phoenix@phoenixmetalcraft.com
www.phoenixmetalcraft.com



Shed No. 402/A, Above Dhiraj Sales,
G.I.D.C., Udyog Nagar, Shankar Tekri,
Jamnagar - 361005

Brass Cable Glands



E1FX Type Double Compression Cable Gland



E1FUNV Type Double Compression Cable Gland



E1FCNF Type Double Compression Cable Gland



E1W Type Double Compression Heavy Duty Cable Gland



A2F Type Cable Gland for all types of unarmoured cables.



E1FW Cable Gland for SWA & AWA Cables



+91-81418 76969
+91-99783 05054



phoenix@phoenixmetalcraft.com
www.phoenixmetalcraft.com



Shed No. 402/A, Above Dhiraj Sales,
G.I.D.C., Udyog Nagar, Shankar Tekri,
Jamnagar - 361005

Brass Cable Glands



**A2FPM Single Compression
Cable Gland**



**A2FPF Single Compression
Cable Gland**

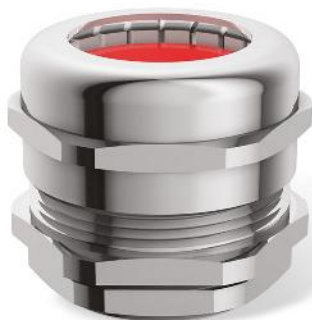

**IP 68 Metric Threaded Single
Compression Cable Gland**



**E1FPF Type Double Compression
Cable Gland**



**E1FPM Type Double Compression
Cable Gland**



A2FCNF Type Cable Gland



+91-81418 76969
+91-99783 05054



phoenix@phoenixmetalcraft.com
www.phoenixmetalcraft.com



Shed No. 402/A, Above Dhiraj Sales,
G.I.D.C., Udyog Nagar, Shankar Tekri,
Jamnagar - 361005

Brass Cable Glands



A1/A2 Type Cable Glands



A2 Type Cable Glands



3PT Single Compression CW Cable Glands



BW Cable Gland - 2PT Armoured



IP 68 Cable Gland - PG Threaded Single Compression



EMC Cable Gland Metric Threaded



EMC Cable Glands - PG Threaded



E1W Double Compression Cable Gland



+91-81418 76969
+91-99783 05054



phoenix@phoenixmetalcraft.com
www.phoenixmetalcraft.com



Shed No. 402/A, Above Dhiraj Sales,
G.I.D.C., Udyog Nagar, Shankar Tekri,
Jamnagar - 361005

Brass Cable Glands



BW Type Cable Glands
4PT Armoured



BWR Cable Glands

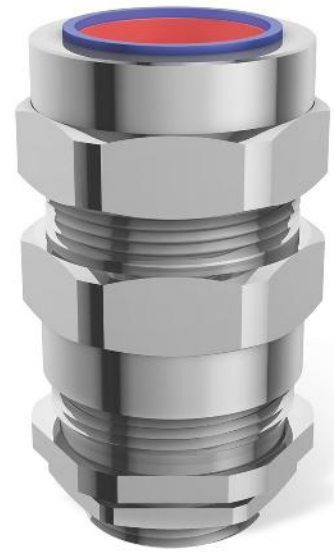

CW Cable Gland - 4PT Single Compression

PRODUCT DETAILS & SPECIFICATION

Throughout the World, Cables requires Glanding, Jointing & Fixing, whether in Hazardous area or Safe Area. Phoenix Metal Craft specialize in manufacturing Flame Proof Industrial Cable Glands covering the wide range of armored and non-armored cable in form of various types like BW, CW, E1W, A1/A2, PG, Marine type etc. After understanding all the critical feature of the glands, we are committed to manufacture safe, leak proof, flameproof and explosion proof glands to avoid all mishaps & prevent any hazards to the health & property.

Key Features:

Cable Glands are produced as per BS 6121 Standard. BW type Cable Glands provide an integral armor clamp for armored cable which provides an electrical bond between the cable armor & the gland. A1/A2 Gland Provides a single pull resistant seal on the outer sheath of an unarmored cable. This Type gland maintains ingress protection of IP66/IP68 to 25 Meters. PG Glands are basically produced as per DIN standard 46320/46255 & available with sprain relief facility with round or hex intermediate sockets. Marine Cable Glands as per JIS standards are basically used for Ship Decks & other marine Applications.

Material:

Brass as per IS 319 or BS 249 or BS 2874:CZ 121 or any high graded brass as per custom specification for main parts & Steel, PVC, LFS, Rubber etc. for various accessories.

Threads:

ISO Metric (MM Threads)

Sizes & Types:

BW, CW, A1/A2 & E1W are available in sizes of 16mm to 90mm In L & S type. PG glands are available from 7pg threads to 63pg. Custom sizes can be developed as per custom demand & requirement.

Finish:

Natural, Nickel, Tin, Chrome are in usual trend or any as per custom demand.

Accessories:

Various Cable Glands are available in kits packs with accessories viz. lock nuts, PVC shrouds or LSF shrouds and brass earth tags. Any special accessory can be incorporated in Kit Pack as per custom requirement.

Let's make something innovative together, Contact Us



+91-81418 76969
+91-99783 05054



phoenix@phoenixmetalcraft.com
www.phoenixmetalcraft.com



Shed No. 402/A, Above Dhiraj Sales,
G.I.D.C., Udyog Nagar, Shankar Tekri,
Jamnagar - 361005



Phoenix Metal Craft

An immortal spirit of manufacturing



Brass Fasteners

COMPANY PROFILE

Phoenix Metal Craft successfully established itself as a highly reliable manufacturer, exporter and trader of a range of automotive parts, precision brass fitting parts and manufacture any metal parts i.e. Brass, M.S, S.S, Copper, Aluminium etc, as per customer provided drawing, specifications or sample.

We are equipped with machinery consisting of header machines station header machine, CNC, Turning machine and highspeed roll die threading machine. We are quality conscious and at the same time competitive enough to be an attractive supplier to you. The Quality ranges that we manufacture are highly durable and chemical resistant.

We always welcome to the development of the new Products. We Manufacture Brass, Copper & Other Metal Components on the base of Sample, Drawing, or Standards reference. Our Products have confirmed the requirement of RoHS of European Standard.

OUR PRODUCTS RANGE

- Brass Ball Valve
- Brass Battery Terminals
- Brass Cable Glands
- Brass Earthing Equipments And Accessories
- Brass Electrical Plug Pins And Sockets
- Brass Fasteners
- Brass HRC Fuse Contacts
- Brass Insert
- Brass Neutral Link
- Brass Sheet Cutting And Pressed Parts
- Brass Standoff And Spacer
- Brass Terminals For PCB Connector Block
- Brass Hardware Products
- CNC Turned Parts
- Special Brass Turned Parts
- Any Kind of Metal Components As Per Sample, Drawing or Standard Reference

**Let's make something innovative together,
We welcome you to share a healthy long-term business relationship with us.**

+91-81418 76969
+91-99783 05054

✉ phoenix@phoenixmetalcraft.com
www.phoenixmetalcraft.com

📍 Shed No. 402/A, Above Dhiraj Sales,
G.I.D.C., Udyog Nagar, Shankar Tekri,
Jamnagar - 361005

Brass Fasteners



Brass Fasteners



Product Details & Specification

We provide a vast range of high quality fasteners according to its diverse applications. We use quality-approved raw materials as inputs for the production of our finished goods. We offer various types of brass screws and fasteners including Machine Screws, Wood Screws, Mirror Screws and Dom Nut. Wood screws and machine screws available in countersunk, Philips, raised, pan, round & cheese head. We also manufacture as per customer specifications, drawing and requirements. Thanks to our hands-on expertise in production for a wide range of fasteners, we have become preferred providers for many clients across the globe.

Material:

Free Cutting Brass IS 319 Type (I) or BS 249 Type (I) or High Grade Any Special Material Composition as per customers requirement.

Threads/Standards:

ISO Metric, BA, BSW, BSP, BSB, BSF, PG, NPT, NPTF, UNC, UNF, UNEF etc... & Any as per Customer's Specification

Finish/Coating:

Natural, Nickle Plated, Silver Plated, Tin Plated and As per customer's Specification.

Size:

Begins from M2 or equivalent threads and up to any size as per Customer's Specification



Phoenix Metal Craft

An immortal spirit of manufacturing



CNC Turned Parts

COMPANY PROFILE

Phoenix Metal Craft successfully established itself as a highly reliable manufacturer, exporter and trader of a range of automotive parts, precision brass fitting parts and manufacture any metal parts i.e. Brass, M.S, S.S, Copper, Aluminium etc, as per customer provided drawing, specifications or sample.

We are equipped with machinery consisting of header machines station header machine, CNC, Turning machine and highspeed roll die threading machine. We are quality conscious and at the same time competitive enough to be an attractive supplier to you. The Quality ranges that we manufacture are highly durable and chemical resistant.

We always welcome to the development of the new Products. We Manufacture Brass, Copper & Other Metal Components on the base of Sample, Drawing, or Standards reference. Our Products have confirmed the requirement of RoHS of European Standard.

OUR PRODUCTS RANGE

- Brass Ball Valve
- Brass Battery Terminals
- Brass Cable Glands
- Brass Earthing Equipments And Accessories
- Brass Electrical Plug Pins And Sockets
- Brass Fasteners
- Brass HRC Fuse Contacts
- Brass Insert
- Brass Neutral Link
- Brass Sheet Cutting And Pressed Parts
- Brass Standoff And Spacer
- Brass Terminals For PCB Connector Block
- Brass Hardware Products
- CNC Turned Parts
- Special Brass Turned Parts
- Any Kind of Metal Components As Per Sample, Drawing or Standard Reference

**Let's make something innovative together,
We welcome you to share a healthy long-term business relationship with us.**



+91-81418 76969
+91-99783 05054



phoenix@phoenixmetalcraft.com
www.phoenixmetalcraft.com



Shed No. 402/A, Above Dhiraj Sales,
G.I.D.C., Udyog Nagar, Shankar Tekri,
Jamnagar - 361005

CNC Turned Parts



CNC - 0001



CNC - 0002



CNC - 0003



CNC - 0004



CNC - 0005



CNC - 0006

CNC Turned Parts



Product Details & Specification

High Quality Customized Turned Parts with great precision & Accuracy can be made very effectively by our CNC Machines in Metals like Brass, Stainless steel & Mild Steel and Aluminum. We make the components with accuracy of as low as 10 microns.

Material:

- Free Cutting Brass IS 319 Type (I) or BS 249 Type (I) or High Grade
- Any Special Brass Material Composition as per customers requirement
- Stainless Steel Turning Grades like 303, 304 etc
- Mild Steel Grades like EN 1A (BS 970 230M07) etc
- Aluminum Turning Grades like 1070 etc

Threads/Standards:

ISO Metric (MM Threads), British Standard Threads BSP, BSPT, BSW, BSF, BA, ASTM threads like NPT, NPTF, UNC, UNF PG Threads, ACME Threads, Edison Threads or almost any threads as per custom specification

Finish/Coating:

Natural Clean, Nickel, Silver, Tin, White, Yellow or Blue Zinc

Features:

- Very High Quality Parts can be made of Turning diameter between 10mm to 70mm
- Accuracy of 10 to 15 microns can be achieved with high precision
- Provides high quality surface finish
- High Processing accuracy to achieve Zero defect products leading to 0 PPM
- Ideal for highly customized Precision components
- Complex parts can be made effectively
- Small batch quantity products can be undertaken which is of benefits to customers whose requirements are small or change at short notice
- Any Kind of special turned parts can be made as per customer's specifications



Phoenix Metal Craft
An immortal spirit of manufacturing



Special Brass Turned Parts

COMPANY PROFILE

Phoenix Metal Craft successfully established itself as a highly reliable manufacturer, exporter and trader of a range of automotive parts, precision brass fitting parts and manufacture any metal parts i.e. Brass, M.S, S.S, Copper, Aluminium etc, as per customer provided drawing, specifications or sample.

We are equipped with machinery consisting of header machines station header machine, CNC, Turning machine and highspeed roll die threading machine. We are quality conscious and at the same time competitive enough to be an attractive supplier to you. The Quality ranges that we manufacture are highly durable and chemical resistant.

We always welcome to the development of the new Products. We Manufacture Brass, Copper & Other Metal Components on the base of Sample, Drawing, or Standards reference. Our Products have confirmed the requirement of RoHS of European Standard.

OUR PRODUCTS RANGE

- Brass Ball Valve
- Brass Battery Terminals
- Brass Cable Glands
- Brass Earthing Equipments And Accessories
- Brass Electrical Plug Pins And Sockets
- Brass Fasteners
- Brass HRC Fuse Contacts
- Brass Insert
- Brass Neutral Link
- Brass Sheet Cutting And Pressed Parts
- Brass Standoff And Spacer
- Brass Terminals For PCB Connector Block
- Brass Hardware Products
- CNC Turned Parts
- Special Brass Turned Parts
- Any Kind of Metal Components As Per Sample, Drawing or Standard Reference

**Let's make something innovative together,
We welcome you to share a healthy long-term business relationship with us.**



+91-81418 76969
+91-99783 05054



phoenix@phoenixmetalcraft.com
www.phoenixmetalcraft.com



Shed No. 402/A, Above Dhiraj Sales,
G.I.D.C., Udyog Nagar, Shankar Tekri,
Jamnagar - 361005

Special Brass Turned Parts

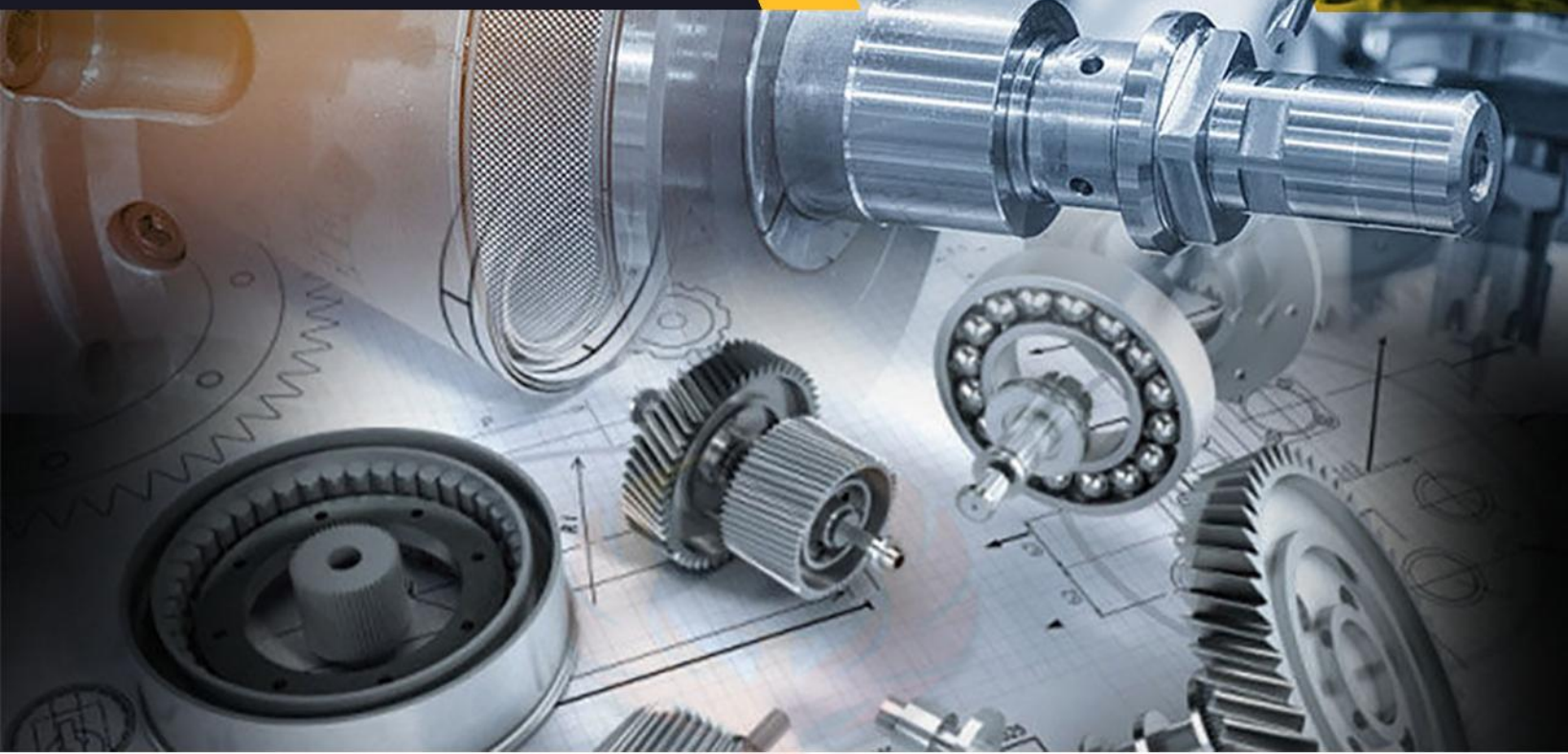

Product Details & Specification

We specialize in producing critical parts with the tolerances as low as 0.03mm. We can turn any diameter right from 1mm to 50mm. Precision Turned Components are used in various electric gadgets, home appliances and in almost all industries in one way or another. We have a highly sophisticated machine which includes Auto trouble, Multi-Rotary Index machines & up to 5 axis SPMs which carries multi operations in single stage giving substantial production & world class quality.

Material:

Free Cutting Brass IS 319 Type (I) or BS 249 Type (I) or High Grade, Any Special Brass Material Composition as per customers requirement

Threads/Standards:

ISO Metric (MM Threads), BA, BSW (Inches), UNC, UNF or Any as per custom design.

Finish/Coating:

Natural, Nickle Plated, Tin Plated special brass turned parts or any coating as per customer specification.

Features:

Any kind of special turned parts can be made as per customer's specifications.

Length / Size:

Begins from M2 or equivalent threads and up to any size as per custom design or requirement

Let's make something innovative together, Contact Us



+91-81418 76969
+91-99783 05054



phoenix@phoenixmetalcraft.com
www.phoenixmetalcraft.com



Shed No. 402/A, Above Dhiraj Sales,
G.I.D.C., Udyog Nagar, Shankar Tekri,
Jamnagar - 361005